

RESMED

RESMED **S7**[™] *Lightweight*
USER'S MANUAL
ROW English

Reorder number: 308191/2 06 12



ResMed Ltd (Manufacturer) 1 Elizabeth Macarthur Drive Bella Vista NSW 2153 Australia
ResMed Corp (US Designated Agent) 14040 Danielson Street Poway CA 92064-6857 USA
ResMed (UK) Ltd (EU Authorized Representative) 65 Milton Park Abingdon Oxfordshire OX14 4RX UK
ResMed Offices Australia, Austria, Brazil, Finland, France, Germany, Hong Kong, Japan, Malaysia, Netherlands, New Zealand, Norway, Singapore, Spain, Sweden, Switzerland, UK, USA (see www.resmed.com for contact details).

Protected by patents: US 4944310, US 5199424, US 5522382, US 6705315. Other patents pending.
Protected by design registrations: AU 147283, AU 147335, AU 147336, CH 128.709, CH 128.710, CH 128.711, CH 128.712, DE 40201723, DE 40202007, DE 40202008, DE 40202020, ES 153514, ES 153515, ES 153516, ES 153518, ES 156135, ES 156136, FR 021395, FR 021396, FR 021397, FR 021407, GB 3001791, GB 3001819, GB 3001820, GB 3001821, JP 1164087, JP 1164265, JP 1164266, JP 1164267, SE 75598, SE 75599, SE 75600, SE 75715, US D467335, US D468011, US D476077, US D477868, US D487311, US D497203, US D503796. Other designs pending.

HumidAire and S7 are trademarks of ResMed Ltd. HumidAire is registered in U.S. Patent and Trademark Office.

© 2006 ResMed Ltd.



CONTENTS

INTRODUCTION	1
DEFINITIONS	1
USER/OWNER RESPONSIBILITY	1
MEDICAL INFORMATION	1
WHAT A RESMED S7™ LIGHTWEIGHT UNIT IS FOR	1
TELL YOUR DOCTOR IF...	1
WARNINGS	2
CAUTIONS	3
THE RESMED S7 LIGHTWEIGHT SYSTEM	5
RESMED S7 LIGHTWEIGHT COMPONENTS	5
MASKS	6
HUMIDIFIER	6
PREPARING FOR USE	7
SETTING UP THE RESMED S7 LIGHTWEIGHT	7
FEATURES OF THE RESMED S7 LIGHTWEIGHT	12
OPERATING INSTRUCTIONS	15
STARTING TREATMENT	15
STOPPING TREATMENT	15
HELPFUL HINTS	16
CLEANING AND MAINTENANCE	17
DAILY	17
WEEKLY	17
PERIODICALLY	17
REPLACING THE AIR FILTER	18
SERVICING	18
TROUBLESHOOTING	19
SYSTEM SPECIFICATIONS	21
LIMITED WARRANTY	27
INDEX	29

INTRODUCTION

DEFINITIONS

This manual contains special terms that appear in the text to draw your attention to specific and important information.



WARNING

Alerts you to possible injury.



CAUTION

Explains special measures for the safe and effective use of the device.

Note: *Is an informative or helpful note.*

USER/OWNER RESPONSIBILITY

The user or owner of this system shall have sole responsibility and liability for any injury to persons or damage to property resulting from:

- operation which is not in accordance with the operating instructions supplied
- maintenance or modifications carried out unless in accordance with authorised instructions and by authorised persons.

Please read this manual carefully before use.

MEDICAL INFORMATION

WHAT A RESMED S7™ LIGHTWEIGHT UNIT IS FOR

The RESMED S7™ LIGHTWEIGHT system is intended for the treatment of adult patients with obstructive sleep apnoea (OSA).

TELL YOUR DOCTOR IF...

You must tell your doctor, and CPAP (continuous positive airway pressure) therapy must not be used, if you have any of the following conditions:

- pneumothorax or pneumomediastinum (air in the pleural cavity or mediastinum)
- severe heart failure, low blood pressure or dehydration
- surgery to the brain, middle or inner ear, pituitary gland, or sinuses
- respiratory distress syndrome
- middle ear infection or perforated ear drum
- severe nosebleed.

WARNINGS

CPAP therapy should be used with caution if you have any of the following conditions:

- respiratory failure
- cavities or cysts in the lung (called bullae, and usually due to emphysema), or previous history of pneumothorax
- previous history of severe nosebleed
- sinus infection.

Tell your doctor if you have any of these conditions. Your doctor will advise you whether the likely benefits of CPAP therapy outweigh the expected risks.

Special care should be exercised if you are dehydrated, or may become dehydrated, for example as a result of fluid restriction or diuretic therapy (including changes in therapy).

Discontinue therapy and seek medical advice if, during therapy or when you start therapy each night, you feel faint or light-headed.

The following are general warnings that pertain to your use of a **RESMED S7 LIGHTWEIGHT** unit. Specific warnings appear next to the relevant instructions in the manual.

- **This is NOT a life support device.** It may stop operating with power failure or if a fault occurs in the unit.
- The air flow for breathing produced by this device can be as much as 6°C (11°F) higher than the temperature of the room. Caution should be exercised if the room temperature is warmer than 32°C (90°F).
- The **RESMED S7 LIGHTWEIGHT** unit should only be used with masks (and connectors)* recommended by ResMed, or by your physician or respiratory therapist. A mask should not be used unless the **RESMED S7 LIGHTWEIGHT** unit is turned on and operating properly. The vent hole or holes associated with the mask should never be blocked.

Explanation: The **RESMED S7 LIGHTWEIGHT** unit is intended to be used with special masks (or connectors)* which have vent holes to allow continuous flow of air out of the mask. When the device is turned on and functioning properly, new air from the device flushes the exhaled air out through the mask vent holes. However, when the device is not operating, insufficient fresh air will be provided through the mask, and the exhaled air may be rebreathed. Rebreathing of exhaled air for longer than several minutes can, in some circumstances, lead to suffocation. This applies to most models of CPAP devices.

- The **RESMED S7 LIGHTWEIGHT** unit should only be connected to the components, humidifiers or accessories specified in this manual. Connection of other items may result in injury, or damage to the **RESMED S7 LIGHTWEIGHT** unit.
- At low pressures, the flow through the exhalation ports of your mask may not clear all exhaled gas from the tubing. Some rebreathing may occur.
- This device is not intended for use with supplemental oxygen.

* Ports may be incorporated in the mask or in connectors that are near the mask.

- Explosion hazard—do not use in the vicinity of flammable anaesthetics.
- Blocking the hose while in operation could lead to overheating of the device.

WARNINGS RELATED TO TREATMENT



WARNING

- If you stop your CPAP treatment, your sleep apnoea will return.
- Always consult your clinician if you expect to be in a situation where you cannot use your **RESMED S7 LIGHTWEIGHT** unit.
- If you are admitted to a hospital or prescribed any other form of medical treatment, always inform the medical staff that you are being treated with CPAP. It is also important to contact the clinician who is treating you for sleep apnoea.
- If you experience an infection of the upper respiratory tract, middle ear or sinuses, contact your clinician before continuing your CPAP treatment. You may be advised to stop treatment until the infection has cleared. If you continue with treatment during an infection, be sure to clean your mask and tubing after every use.

CAUTIONS

The following are general cautions. Specific cautions appear next to the relevant instructions in the manual.

- Do not open the **RESMED S7 LIGHTWEIGHT** case. There are no user serviceable parts inside. Repairs and internal servicing should only be performed by an authorised service agent.

POSSIBLE SIDE EFFECTS

The **RESMED S7 LIGHTWEIGHT** flow generator helps you have a good night's sleep. However, you need to be aware of possible problems that may arise during CPAP treatment.



WARNING

Consult your clinician immediately if you experience any of the following symptoms during your CPAP treatment:

- headache
- middle ear or sinus discomfort
- chest pain
- dryness of the nose, mouth or throat
- feeling bloated due to air swallowing
- air continually leaking out of the mouth while sleeping
- recurrence of any sleep apnoea symptoms while on CPAP.

Skin irritation may occur from sensitivity to the mask materials or from excessively tight headgear straps. A correctly fitted mask and appropriately adjusted straps will often prevent skin irritation. If problems persist, contact your clinician for advice.

THE RESMED S7 LIGHTWEIGHT SYSTEM

RESMED S7 LIGHTWEIGHT COMPONENTS

Please identify and familiarise yourself with the following components of the RESMED S7 LIGHTWEIGHT unit:

**ResMed S7 Lightweight unit
Front view**

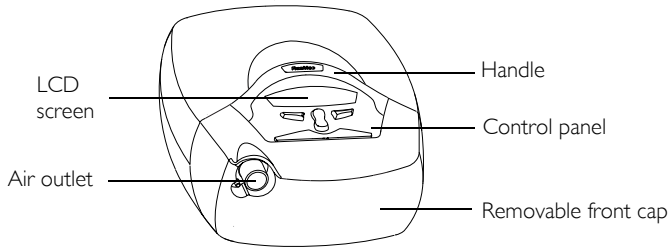

Air tubing, 2m (6ft6in)

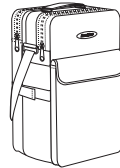

Carry bag

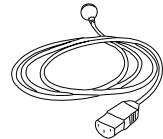

Power cord

ACCESSORIES

The following accessories may be purchased separately.

RESMED S7 LIGHTWEIGHT ACCESSORIES



Air tubing,
3m (9ft10in)

HUMIDIFIER ACCESSORIES

(HUMIDAIRE and ResMed PASSOVER only)



Medium air tubing
52cm (21in) for
humidifier connection

MASKS

You will also need a **ResMed mask system** (supplied separately).

The following ResMed mask systems are recommended for use with the **RESMED S7 LIGHTWEIGHT**:



MIRAGE VISTA™
MASK



ULTRA MIRAGE™
MASK

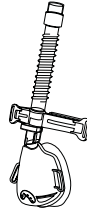

MIRAGE™ MASK



PROTÉGÉ™ MASK
(not available in
all markets)



MIRAGE™ FULL FACE
MASK SERIES 2



MIRAGE™ FULL FACE MASK



MODULAR MASK

HUMIDIFIER

A humidifier may be required if you are experiencing dryness of the nose, throat or mouth. The **RESMED S7 LIGHTWEIGHT** is compatible for use with the following humidifiers:

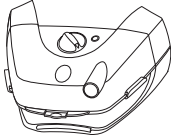

HUMIDAIRE 2i™ heated humidifier



HUMIDAIRE 2iC passover humidifier
(not available in all markets)

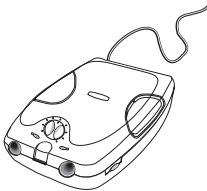

HUMIDAIRE™ heated humidifier

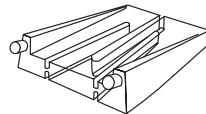

ResMed PASSOVER humidifier
(not available in all markets)



WARNING

Only the HumidAire 2i, HumidAire 2iC, HumidAire heated humidifier and the ResMed Passover are compatible for use with the ResMed S7 Lightweight. Please refer to “Warnings” on page 2.

Note: ResMed regularly releases new products. Please check our website at www.resmed.com.

PREPARING FOR USE

SETTING UP THE RESMED S7 LIGHTWEIGHT

- 1 Place the RESMED S7 LIGHTWEIGHT unit on a table near the head of your bed.



CAUTION

Be careful not to place the device where it can be bumped or where someone is likely to trip over the power cord.

Note: The ResMed S7 Lightweight unit may be placed on the floor beside or underneath your bed. Ensure that the area is free from dust and clear of bedding, clothes or any other objects that could block the air inlet.

- 2 Connect the power cord to the socket at the rear of the flow generator. Plug the other end of the power cord into a power outlet.



WARNING

- Make sure the power cord and plug are in good condition and the equipment is not damaged.
- The air filter cover protects the device in the event of accidental liquid spillage onto the device. Ensure that the air filter and air filter cover are fitted at all times.

- 3 Connect one end of the air tubing firmly onto the air outlet of the unit.

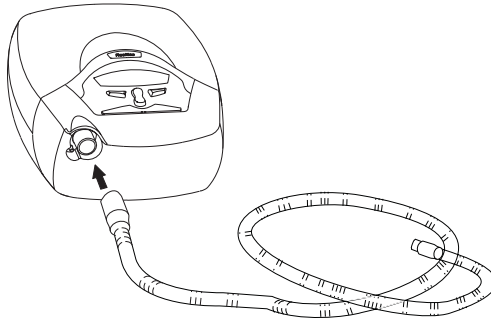

WARNING

Only ResMed air tubing should be used with your flow generator. A different type of air tubing may alter the pressure you actually receive reducing the effectiveness of your treatment.

- 4 Assemble your mask system according to the mask user instructions.

- 5 Connect your mask system to the free end of the air tubing.

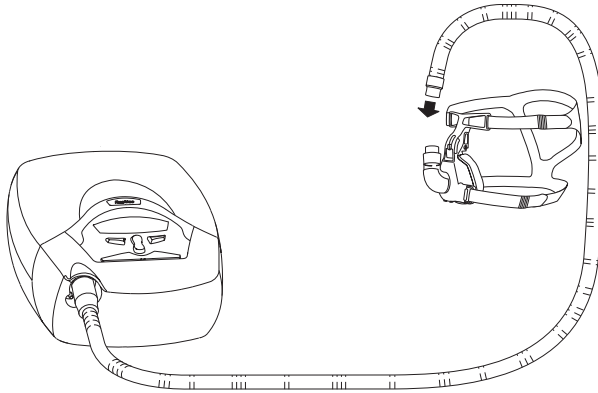

The **RESMED S7 LIGHTWEIGHT** is now ready for use. To start treatment, see “Operating Instructions” on page 15.

HUMIDIFIER USE

Notes

- The ResMed S7 Lightweight has no humidifier setting options.
- The ResMed S7 Lightweight does not have the Warm-Up and cooling down features mentioned in the HumidAire 2i User’s Manual. When the HumidAire 2i is attached to the ResMed S7 Lightweight, you may begin therapy immediately.

HUMIDAIRE 2i™

The **HUMIDAIRE 2i™** attaches to the front of the **RESMED S7 LIGHTWEIGHT** to provide heated humidification. No other accessories are required for its use. Please refer to the *HumidAire 2i User’s Manual* for details.

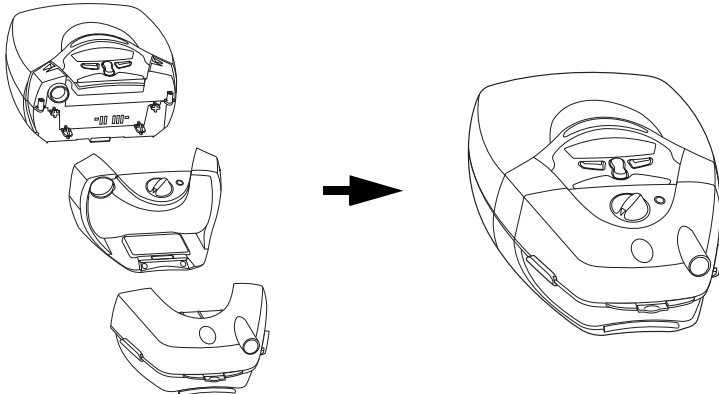

HUMIDAIRE 2iC (not available in all markets)

The **HUMIDAIRE 2iC** attaches to the front of a **RESMED S7 LIGHTWEIGHT** unit to provide passover humidification. No other accessories are required for its use. Please refer to the *HumidAire 2iC User's Manual* for details.

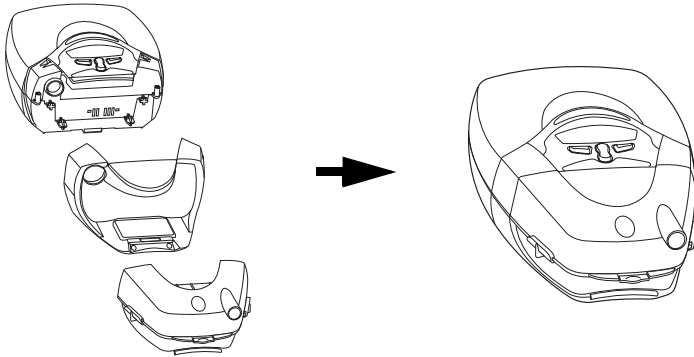

HUMIDAIRE™ AND RESMED PASSOVER (not available in all markets)

Medium size 52cm (21 in) air tubing is a necessary accessory for connecting the **RESMED S7 LIGHTWEIGHT** unit to the **HUMIDAIRE™** and **ResMed PASSOVER** humidifiers.

1 Fill the **HUMIDAIRE** or **PASSOVER** with water as described in the humidifier manual.

2 HumidAire Users Place the filled water chamber inside the **HUMIDAIRE**. Connect the medium 52cm (21 in) air tubing to the left connector port, and the long air tubing 2m (6ft6in) or 3m (9ft10in) to the right connector port on the humidifier. Close the **HUMIDAIRE** lid.

ResMed Passover Users Connect the medium 52cm (21 in) air tubing to the left connector port, and the long air tubing 2m (6ft6in) or 3m (9ft10in) to the right connector port on the humidifier.

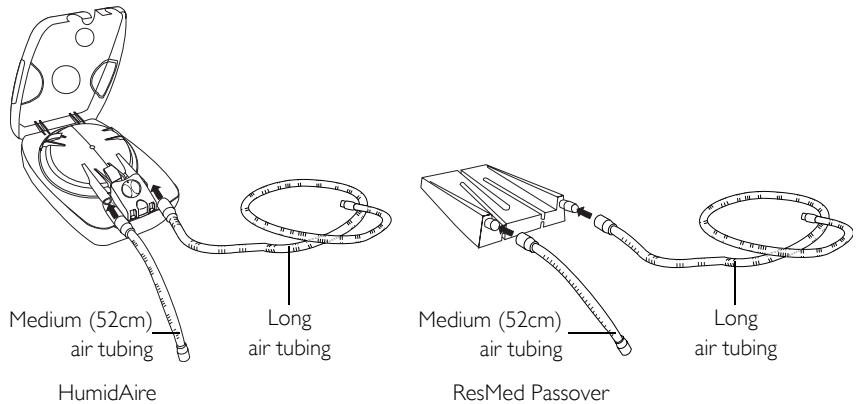

- 3 Place the **RESMED S7 LIGHTWEIGHT** on top of the **HUMIDAIRE** or **PASSOVER**. Do not place the **RESMED S7 LIGHTWEIGHT** unit underneath the humidifier. (This is to avoid water spilling into the unit.)

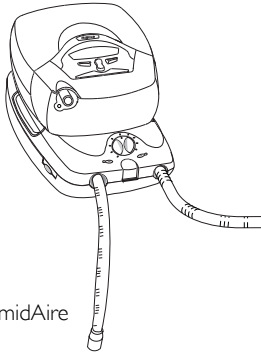

HumidAire

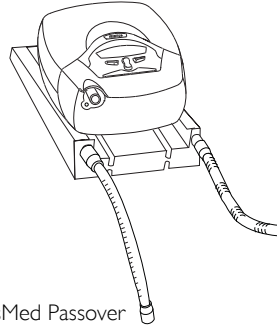

ResMed Passover

-
- 4 **HumidAire Users** Connect the free end of the medium air tubing to the air outlet of the **RESMED S7 LIGHTWEIGHT**.
ResMed Passover Users Connect the free end of the medium air tubing to the air outlet of the **RESMED S7 LIGHTWEIGHT**.

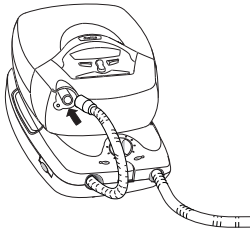

HumidAire

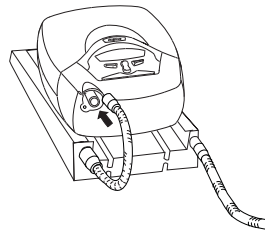

ResMed Passover

-
- 5 Connect the mask system to the free end of the long air tubing. The final assembly should look like this:

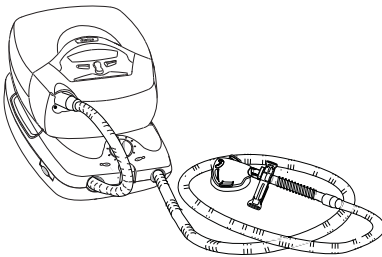

HumidAire

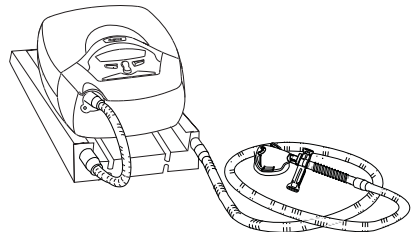

ResMed Passover

-
- 6 **HumidAire Users** Plug the **HUMIDAIRE** power cord into a power outlet and turn the power on.

- 7 Connect the power cord to the socket at the rear of the **RESMED S7 LIGHTWEIGHT**. Plug the other end of the power cord into a power outlet and turn the power on.



WARNING

Make sure that the power cord and plug are in good condition and the equipment is not damaged.

- 8 The **RESMED S7 LIGHTWEIGHT** is now ready for use with the **HUMIDAIRE** or ResMed **PASSOVER**.

ALTITUDE COMPENSATION

Changes in altitude will affect the pressure delivered by the **RESMED S7 LIGHTWEIGHT**. The device has a feature which compensates for these changes in altitude.

As you move or travel with the **RESMED S7 LIGHTWEIGHT** to areas of different altitudes, you will need to adjust the altitude compensation setting in the device. To change the altitude compensation setting, see “Using the Menu” on page 12.

There are three altitude settings to choose from:

Altitude Settings	
0–2000ft	(0–610m)
2001–4000ft	(611–1219m)
4001–7000ft	(1220–2134m)

For example, if you are at an altitude of 3107ft (947m), your altitude compensation setting would be 2001–4000ft (611–1219m), as 3107ft (947m) falls within that range.

Note: *If you are above 7000ft (2134m), consider consulting your clinician.*



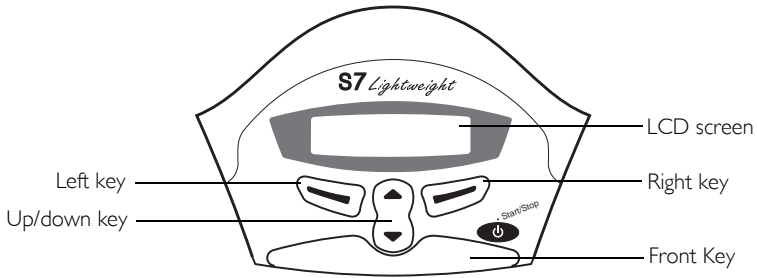

FEATURES OF THE RESMED S7 LIGHTWEIGHT

LCD SCREEN AND KEYPAD

The control panel of the RESMED S7 LIGHTWEIGHT includes an LCD screen and keypad.



The RESMED S7 LIGHTWEIGHT keypad has the following keys:

Key	Function
Front 	<ul style="list-style-type: none">Starts or stops treatment
Up/Down 	<ul style="list-style-type: none">Allows you to scroll through the ResMed S7 LIGHTWEIGHT menus and setting options.
Left 	<ul style="list-style-type: none">Performs the function indicated by the guiding text displayed above it on the LCD screen. Guiding text includes menu, change and apply.
Right 	<ul style="list-style-type: none">Performs the function indicated by the guiding text displayed above it on the LCD screen. Guiding text includes exit and cancel.

To assist you in adjusting the RESMED S7 LIGHTWEIGHT the keypad is equipped with a backlight. The keypad is backlit with power-up of the unit. Under normal operation, the keypad remains illuminated to indicate that the device is ON.

USING THE MENUS

The ResMed S7 LIGHTWEIGHT unit provides a set of functions which are arranged in menus. Via the LCD screen, the menus allow you to view and change the settings for a particular function. You can access the menus when the Ramp screen is displayed. After the Welcome Screen appears and device self-checks are complete, the Ramp screen appears. In the Ramp screen, you can immediately set a ramp time. Ramp time is the period during which the pressure increases from a low comfortable pressure to

the prescribed treatment pressure. Ramp time can be altered in 5 minute increments (from 0min to a maximum ramp time set by your clinician) by using the **Up/Down** key.

See Figure 1 for a summary of the **RESMED S7 LIGHTWEIGHT** menus.

- To access the **RESMED S7 LIGHTWEIGHT** menus:
Press the **Left** key (menu) while the Ramp screen is displayed.
- To scroll through items within a menu:
Press the **Up/Down** key
- To change a setting option for a function:
 1. Press the **Left** key (change)
 2. Press the **Up/Down** key until the desired setting option appears.
 3. Press the **Left** key (apply) to select the setting option.
- To exit without changing options:
Press the **Right** key (cancel)
- To exit out of a menu or submenu:
Press the **Right** key (exit)

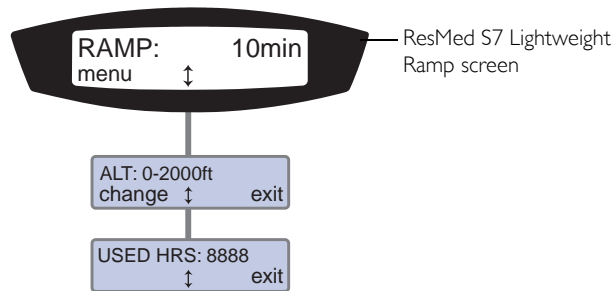

Figure 1: ResMed S7 Lightweight Menu Series

MENU FUNCTIONS

The **RESMED S7 LIGHTWEIGHT** menu functions are summarised in Table 1 with a brief description of what each function does and the available setting options. To access these functions see “Using the Menus” on page 12.

SETTINGS MENU

The Settings Menu allows you to view and change certain operating features of the **RESMED S7 LIGHTWEIGHT** unit.

Table 1: Settings Menu Functions

Function	Function Description	Setting Options
Altitude (Compensation)	Sets the altitude compensation range.	0–2000ft (0–610m), 2001–4000ft (611–1219m), 4001–7000ft (1220–2134m)
Used hours	Displays the total number of treatment hours.	(View only)

OPERATING INSTRUCTIONS

STARTING TREATMENT

The RESMED S7 LIGHTWEIGHT unit should be assembled beside your bed with the air tubing and mask system connected. See "Setting Up The ResMed S7 Lightweight" on page 7.

- 1 Turn the main power switch at the back of the unit to on (I).

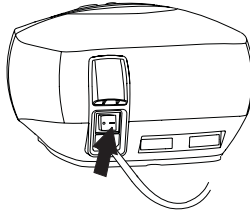

When the RESMED S7 LIGHTWEIGHT is turned on, the software version is displayed on the LCD screen. The Ramp screen then appears.

- 2 Fit your mask as described in the mask user instructions.
- 3 Lie down and arrange the air tubing so that it is free to move if you turn in your sleep.



CAUTION

- Do not leave long lengths of air tubing around the top of your bed. It could twist around your head or neck while you are sleeping.
- Make sure the area around the flow generator is dry and clean. It should also be clear of bedding, clothes and other potential blockages.

- 4 To start treatment, press the **Front** key.

If a ramp time is selected, the LCD will display the word RAMPING with set pressure indicated as dashes. At the end of the ramping period the LCD will display CPAP. After starting treatment, the LCD will look similar to one of the screens below.

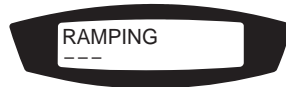

The dashes represent the set pressure, where each dash is approximately equivalent to 2 cmH₂O pressure. For example, 6 dashes represents approximately 12 cmH₂O pressure.

STOPPING TREATMENT

To stop treatment at any time, remove your mask and press the **Front** key.

HELPFUL HINTS

STARTING OUT

FIRST USE

When you first use your **RESMED S7 LIGHTWEIGHT** unit, you may feel uncomfortable breathing against the air flow. This is normal. You will continue to breathe normally while you sleep. Take time to adjust to this new sensation. Taking a few deep breaths may help.

GETTING UP

If you need to get up during the night, remove your mask and turn the flow generator off. Always remember to put your mask on and turn your flow generator on when you return to bed.

MOUTH LEAKS

If using a nasal mask, try to keep your mouth closed during treatment. Air leaks from your mouth can decrease the effectiveness of your treatment. If mouth leaks are a problem, a full face mask or chin strap may help. Contact your clinician or equipment supplier for further details.

MASK FITTING

The flow generator delivers the most effective treatment when the mask is well fitted and comfortable. Treatment can be affected by leaks, so it is important to eliminate any leaks that may arise.

If you have problems trying to get a comfortable mask fit, contact your sleep clinic or equipment supplier. You may benefit from a different size or style of mask.

Before wearing your mask, wash your face to remove excess facial oils. This will allow a better fit and prolong the life of the mask cushion.

NASAL IRRITATION

DRYNESS

You may experience dryness of the nose, mouth and/or throat during the course of treatment, especially during winter. In many cases, a humidifier may resolve this discomfort. Contact your clinician for advice.

RUNNY OR BLOCKED NOSE

You may experience sneezing and/or a runny or blocked nose during the first few weeks of treatment. In many cases, nasal irritation can be resolved with a humidifier. Consult your clinician for advice.

TRAVELLING WITH THE RESMED S7 LIGHTWEIGHT

INTERNATIONAL USE

Your **RESMED S7 LIGHTWEIGHT** flow generator has an internal power adapter that enables it to operate in other countries. It will operate on power supplies of 100–240V and 50–60Hz. No special adjustment is necessary, but you may need a plug adapter for the power outlet.

CLEANING AND MAINTENANCE

You should regularly carry out the cleaning and maintenance described in this section.

DAILY

1. Disconnect the air tubing and hang it in a clean, dry place until next use. Do not hang the air tubing in direct sunlight as it may harden and crack over time.
2. Clean the mask according to the mask user instructions.
3. If you are using a humidifier, clean it according to the instructions in the manual.

WEEKLY

1. Remove the air tubing from the **RESMED S7 LIGHTWEIGHT** unit and the mask.
2. Wash the mask system according to the instructions supplied with it.
3. Wash the air tubing in warm water using mild detergent. Rinse thoroughly, hang and allow to dry.
4. Before next use, assemble the mask and headgear according to the mask user instructions.
5. Reconnect the air tubing to the air outlet and mask.



CAUTION

- Do not use bleach, chlorine-, alcohol- or aromatic-based solutions (including all scented oils), moisturising or antibacterial soaps to clean the cushion, mask, air tubing or the ResMed S7 Lightweight. These solutions may cause hardening and reduce the life of the product.
- Do not wash or dry the mask frame at a temperature above 80°C (176°F). Exposure to higher temperatures may reduce the life of the product.
- Do not hang the air tubing in direct sunlight as the tubing may harden over time and eventually crack.

PERIODICALLY

1. The mask and air tubing are subject to normal wear and tear. Inspect them regularly for damage.
2. Clean the exterior of the flow generator with a damp cloth and mild detergent.
3. Inspect the air filter to check if it is blocked by dirt or contains holes. See “Replacing the Air Filter” on page 18.



WARNING

Beware of electric shock. Do not immerse the flow generator or power cord in water. Always unplug the flow generator before cleaning and be sure that it is dry before reconnecting.



CAUTION

Do not attempt to open the ResMed S7 Lightweight. There are no user serviceable parts inside. Repairs and internal servicing should only be performed by an authorised service agent.

REPLACING THE AIR FILTER

Inspect the air filter every month to check if it is blocked by dirt or contains holes. With normal use of a RESMED S7 LIGHTWEIGHT unit, the air filter needs to be replaced every six months (or more often if your unit is in a dusty environment). To replace the air filter:

1. Remove the air filter cover at the back of the RESMED S7 LIGHTWEIGHT.

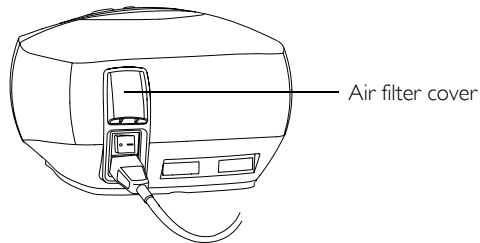

2. Remove and discard the old air filter.
3. Insert a new filter with the blue tinted side facing out from the unit.
4. Replace the air filter cover.



WARNING

Do not wash the air filter. The air filter is not washable or reusable.

Note: The air filter should be inspected once a month.

SERVICING

This product (RESMED S7 LIGHTWEIGHT) should be inspected by an authorised ResMed Service Centre 5 years from the date of manufacture. Prior to this, the device is intended to provide safe and reliable operation provided that it is operated and maintained in accordance with the instructions provided by ResMed. Applicable ResMed warranty details are provided with the device at the time of original supply. Of course, as with all electrical devices, if any irregularity becomes apparent, you should exercise caution and have the device inspected by an Authorised ResMed Service Centre.

The RESMED S7 LIGHTWEIGHT should not require regular servicing if it is maintained according to the instructions in this manual. If you feel that your unit is not performing properly, see “Troubleshooting” on page 19.



CAUTION

Inspection and repair should only be performed by an authorised service agent. Under no circumstances should you attempt to service or repair the flow generator yourself.

TROUBLESHOOTING

If there is a problem, try the following suggestions. If the problem cannot be solved, contact your equipment supplier or ResMed. Do not attempt to open the unit.

Problem	Possible Cause	Solution
<i>No display.</i>	Power not connected or switch at back is not on.	Ensure the power cable is connected and that the switch at the back of the unit is in the ON position.
<i>Insufficient air delivered from the ResMed S7 Lightweight.</i>	Ramp Time is in use.	Wait for air pressure to build up.
	Air filter is dirty.	Replace air filter.
	Air tubing is kinked or punctured.	Straighten or replace tubing.
	Air tubing not connected properly.	Check air tubing.
	Mask and headgear not positioned correctly.	Adjust position of mask and headgear.
	Cap(s) missing from access port(s) on mask.	Replace cap(s).
	Altitude compensation setting is incorrect.	Adjust altitude compensation setting to the correct altitude range.
	Pressure required for treatment may have changed.	See your clinician to adjust the pressure.
<i>Excessive air delivered from the ResMed S7 Lightweight.</i>	Altitude compensation setting is incorrect.	Adjust altitude compensation setting to the correct altitude range.
<i>Displays error message: Exxx (where xxx defines an error code)</i>	Component failure.	Return your ResMed S7 Lightweight for servicing.

SYSTEM SPECIFICATIONS

Performance

Operating pressure range: 4 to 20 cmH₂O

Dimensions (L x W x H): 270mm(10.6in) x 230mm(9.1in) x 141mm(5.6in)

Weight: 1.9kg (4.1lb)

Power Supply

Input range 100–240V, 50–60Hz, < 120VA (maximum power consumption)

Actual power consumption will vary, depending on factors such as the use of accessories, height above sea level and ambient temperature. Power consumption values for typical treatment conditions (using a breathing machine set to 0.5L and 15 breaths/min with 2m (6ft6in) air tubing and a modular table mask) are given in the following table.

Device	Pressure (cmH ₂ O)	Power (VA)
ResMed S7 Lightweight	5	20
	10	24
	15	29
	20	35

Housing Construction: Flame retardant engineering thermoplastic

Environmental Conditions

Operating Temperature: +5°C (+41°F) to +40°C (+104°F)

Operating Humidity: 10%–95% non-condensing

Storage and Transport Temperature: -20°C (-4°F) to +60°C (+140°F)

Storage and Transport Humidity: 10%–95% non-condensing

Electromagnetic Compatibility: Product complies with all applicable electromagnetic compatibility requirements (EMC) according to IEC60601-1-2, for residential, commercial and light industry environments. For further details, see “Guidance and Manufacturer’s Declaration - Electromagnetic Emissions and Immunity” on page 23.

Air Filter: Two-layered, powder-bonded, polyester non-woven fiber

Air Tubing: Flexible plastic, 2m (6ft6in) length

IEC 60601-1 Classifications: Class II (double insulation), Type CF

Note: The manufacturer reserves the right to change these specifications without notice.

GLOSSARY OF SYMBOLS



Attention, consult accompanying documents



Class II equipment



Type CF equipment



IPX1

Drip Proof



Start/Stop



Environmental information

WEEE 2002/96/EC is a European Directive that requires the proper disposal of electrical and electronic equipment. This device should be disposed of separately, not as unsorted municipal waste. To dispose of your device, you should use appropriate collection, reuse and recycling systems available in your region. The use of these collection, reuse and recycling systems is designed to reduce pressure on natural resources and prevent hazardous substances from damaging the environment.

If you need information on these disposal systems, please contact your local waste administration. The crossed-bin symbol invites you to use these disposal systems. If you require information on collection and disposal of your ResMed device please contact your ResMed office, local distributor or go to www.resmed.com/environment.

GUIDANCE AND MANUFACTURER'S DECLARATION - ELECTROMAGNETIC EMISSIONS AND IMMUNITY

Guidance and manufacturer's declaration – electromagnetic emissions

The ResMed S7 Lightweight is intended for use in the electromagnetic environment specified below. The customer or the user of the ResMed S7 Lightweight should assure that it is used in such an environment.

Emissions test	Compliance	Electromagnetic environment - guidance
RF emissions CISPR11	Group 1	The ResMed S7 Lightweight uses RF energy only for its internal function. Therefore, its RF emissions are very low and are not likely to cause any interference in nearby electronic equipment.
RF emissions CISPR 11	Class B	The ResMed S7 Lightweight is suitable for use in all establishments, including domestic establishments and those directly connected to the public low-voltage network that supplies buildings used for domestic purposes.
Harmonic Emissions IEC 61000-3-2	Class A	
Voltage Fluctuations/Flicker Emissions IEC 61000-3-3	Complies	

Medical Electrical Equipment needs special precautions regarding EMC and needs to be installed and put into service according to EMC information provided in this document.

Warnings: The ResMed S7 Lightweight should not be used adjacent to or stacked with other equipment. If adjacent or stacked use is necessary, the ResMed S7 Lightweight should be observed to verify normal operation in the configuration in which it will be used.

The use of accessories (eg Humidifiers) other than those specified in this manual is not recommended. They may result in increased emissions or decreased immunity of the ResMed S7 Lightweight.

Guidance and manufacturer's declaration – electromagnetic immunity

The ResMed S7 Lightweight is intended for use in the electromagnetic environment specified below. The customer or the user of the ResMed S7 Lightweight should assure that it is used in such an environment.

Immunity test	IEC60601-1-2 test level	Compliance level	Electromagnetic environment –guidance
Electrostatic discharge (ESD) IEC 61000-4-2	±6 kV contact ±8 kV air	±6 kV contact ±8 kV air	Floors should be wood, concrete or ceramic tile. If floors are covered with synthetic material, the relative humidity should be at least 30%.
Electrical fast transient/burst IEC 61000-4-4	±2 kV for power supply lines ±1 kV for input/output lines	±2 kV Not Applicable	Mains power quality should be that of a typical commercial or hospital environment.
Surge IEC 61000-4-5	±1 kV differential mode ±2 kV common mode	±1 kV differential mode ±2 kV common mode	Mains power quality should be that of a typical commercial or hospital environment.
Voltage dips, short interruptions and voltage variations on power supply input lines. IEC 61000-4-11	<5% Ut (>95% dip in Ut) for 0.5 cycle 40% Ut (60% dip in Ut) for 5 cycles 70% Ut (30% dip in Ut) for 25 cycles <5% Ut (>95% dip in Ut) for 5 sec	< 12V (>95% dip in 240V) for 0.5 cycle 96V (60% dip in 240V) for 5 cycles 168V (30% dip in 240V) for 25 cycles <12V (>95% dip in 240V) for 5 sec	Mains power quality should be that of a typical commercial or hospital environment. If the user of the ResMed S7 Lightweight requires continued operation during power mains interruptions, it is recommended that the ResMed S7 Lightweight be powered from an uninterruptible power source
Power frequency (50/60 Hz) magnetic field IEC 61000-4-8	3 A/m	3 A/m	Power frequency magnetic fields should be at levels characteristic of a typical location in a typical commercial or hospital environment

NOTE: Ut is the a.c. mains voltage prior to application of the test level.

Guidance and manufacturer's declaration – electromagnetic immunity

The ResMed S7 Lightweight is intended for use in the electromagnetic environment specified below. The customer or the user of the ResMed S7 Lightweight should assure that it is used in such an environment.

Immunity test	IEC60601-1-2 test level	Compliance level	Electromagnetic environment – guidance
Conducted RF IEC 61000-4-6	3 Vrms 150 kHz to 80 MHz	3 Vrms	<p>Portable and mobile RF communications equipment should be used no closer to any part of the ResMed S7 Lightweight, including cables, than the recommended separation distance calculated from the equation applicable to the frequency of the transmitter.</p> <p>Recommended separation distance</p> $d = 1.17 \sqrt{P}$
Radiated RF IEC 61000-4-3	10 V/m 80 MHz to 2.5 GHz	10 V/m	$d = 0.35 \sqrt{P} \text{ 80 MHz to 800 MHz}$ $d = 0.70 \sqrt{P} \text{ 800 MHz to 2.5 GHz}$ <p>where P is the maximum output power rating of the transmitter in watts (W) according to the transmitter manufacturer and d is the recommended separation distance in meters (m). Field strengths from fixed RF transmitters, as determined by an electromagnetic site survey,^a should be less than the compliance level in each frequency range.^b Interference may occur in the vicinity of equipment marked with the following symbol:</p> 

NOTE 1: At 80 MHz and 800MHz, the higher frequency range applies.

NOTE 2: These guidelines may not apply in all situations. Electromagnetic propagation is affected by absorption and reflection from structures, objects and people.

^a Field strengths from fixed transmitters, such as base stations for radio (cellular/cordless) telephones and land mobile radios, amateur radio, AM and FM radio broadcast and TV broadcast cannot be predicted theoretically with accuracy. To assess the electromagnetic environment due to fixed RF transmitters, an electromagnetic site survey should be considered. If the measured field strength in the location in which the ResMed S7 Lightweight is used exceeds the applicable RF compliance level above, the ResMed S7 Lightweight should be observed to verify normal operation. If abnormal performance is observed, additional measures may be necessary, such as reorienting or relocating the ResMed S7 Lightweight.

^b Over the frequency range 150 kHz to 80 MHz, field strengths should be less than 10 V/m.

Recommended separation distances between portable and mobile RF communications equipment and the ResMed S7 Lightweight

The ResMed S7 Lightweight is intended for use in an environment in which radiated RF disturbances are controlled. The customer or the user of the ResMed S7 Lightweight can help prevent electromagnetic interference by maintaining a minimum distance between portable and mobile RF communications equipment (transmitters) and the ResMed S7 Lightweight as recommended below, according to the maximum output power of the communications equipment.

Rated maximum output power of transmitter W	Separation distance according to frequency of transmitter m		
	150kHz to 80MHz $d = 1.17 \sqrt{P}$	80 MHz to 800 MHz $d = 0.35 \sqrt{P}$	800MHz to 2.5 GHz $d = 0.35 \sqrt{P}$
0.01	0.17	0.04	0.04
0.1	0.37	0.11	0.11
1	1.17	0.35	0.35
10	3.69	1.11	1.11
100	11.70	3.50	3.50

For transmitters rated at a maximum output power not listed above, the recommended separation distance d in metres (m) can be determined using the equation applicable to the frequency of the transmitter, where P is the maximum output power rating of the transmitter in watts (W) according to the transmitter manufacturer.

NOTE 1: At 80 MHz and 800 MHz, the separation distance for the higher frequency range applies.

NOTE 2: These guidelines may not apply in all situations. Electromagnetic propagation is affected by absorption and reflection from structures, objects and people.

LIMITED WARRANTY

ResMed warrants that your ResMed product shall be free from defects in material and workmanship for the period specified below from the date of purchase by the initial consumer. This warranty is not transferable.

Product	Warranty Period
ResMed humidifiers, ResControl™, ResLink™, ResTraxx™	1 Year
ResMed flow generators	2 Years
Accessories, mask systems (including mask frame, cushion, headgear and tubing). Excludes single-use devices.	90 Days

Note: *Some models are not available in all regions.*

If the product fails under conditions of normal use, ResMed will repair or replace, at its option, the defective product or any of its components. This Limited Warranty does not cover:

- a) any damage caused as a result of improper use, abuse, modification or alteration of the product;
- b) repairs carried out by any service organization that has not been expressly authorized by ResMed to perform such repairs;
- c) any damage or contamination due to cigarette, pipe, cigar or other smoke;
- d) any damage caused by water being spilled on or into a flow generator.

Warranty is void on product sold, or resold, outside the region of original purchase. Warranty claims on defective product must be made by the initial consumer at the point of purchase.

This warranty is in lieu of all other express or implied warranties, including any implied warranty of merchantability or fitness for a particular purpose. Some regions or states do not allow limitations on how long an implied warranty lasts, so the above limitation may not apply to you.

ResMed shall not be responsible for any incidental or consequential damages claimed to have occurred as a result of the sale, installation or use of any ResMed product. Some regions or states do not allow the exclusion or limitation of incidental or consequential damages, so the above limitation may not apply to you. This warranty gives you specific legal rights, and you may also have other rights which vary from region to region.

For further information on your warranty rights, contact your local ResMed dealer or ResMed office.

INDEX

A

accessories 5
 Air Filter 18, 21
 Air Tubing 21
 Altitude Compensation 11
 Altitude Settings 11

B

Back-light, Keypad 12

C

Cleaning and Maintenance 17
 Cleaning Periodically 17
 Components 5

D

Daily Cleaning 17
 Definitions 1
 Dimensions 21
 Dryness 16

E

Electromagnetic Compatibility 21
 Environmental Conditions 21
 Error Messages 19

F

Features of the ResMed S7 Lightweight 12
 First Use 16
 Flow/Pressure Characteristics 23
 Front Key 12

G

Getting Up 16
 Glossary of Symbols 22

H

Helpful Hints 16
 Housing Construction 21
 HumidAire 9
 HumidAire 2i 8
 HumidAire 2iC 9
 Humidifier 6, 8
 Humidifier Use 8

I

IEC 60601-1 Classifications 21
 International Use 16

K

Keys, functions 12

L

LCD Screen and Keypad 12
 Left Key 12

M

Mask Fitting 16
 Masks 6
 Medical Information 1
 Menu 13
 Menu Functions 13
 Menus, using the ResMed S7 Lightweight
 12
 Mouth Leaks 16

N

Nasal Irritation 16

O

Operating Instructions 15

P

Performance 21
 Power Supply 21
 Preparing for Use 7

R

Ramp
 screen 12
 time 12
 Replacing the Air Filter 18
 ResMed Passover humidifier 9
 Responsibility, user/owner 1
 Right Key 12
 Runny or Blocked Nose 16

S

Servicing 18
 Servicing Menu 15
 Setting Up 7
 Settings Menu 13
 Side Effects 3
 Starting Treatment 15
 Stopping Treatment 15
 System Specifications 21

T

Travelling 16

Troubleshooting 19

U

Up/Down Key 12

User/Owner Responsibility 1

Using the Menus 12

W

Warnings Related to Treatment 3

Warranty 27

Weekly Cleaning 17

Weight 21