

TRUAIRE-5

5-LITER OXYGEN CONCENTRATOR

Manual

MODEL: O2C5L

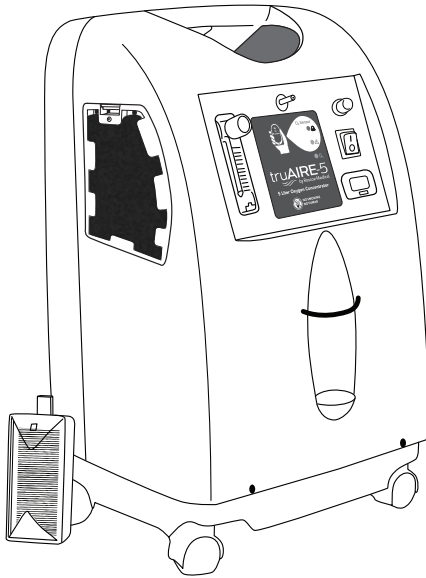

Read this manual before operating the concentrator.
Save these instructions for future reference.

TABLE OF CONTENTS

	Page
1. Introduction	3
Intended Use	
Contraindications	
2. Safety Symbols and Definitions	3
3. Labeling Symbols and Descriptions	4
4. Safety Precautions and Warnings	5
5. Illustration of Parts	8
6. Technical Specifications	9
7. Getting Started	10
Unpacking	
Packing List	
Inspection	
Storage	
8. Operating the Concentrator	10
Select a Location	
Setting up the Concentrator	
Flow Rate	
O2 Sensor and Alarms	
Turning off the Concentrator	
9. Maintenance	12
Cleaning the Cabinet	
Cleaning the Cabinet Filter	
Replacing the Intake Filter	
Cleaning the Humidifier Bottle	
Cleaning and Disinfection between Patients	
10. Preventive Maintenance Log	15
11. Troubleshooting Guide	16
12. EMC Information	17
13. Limited Warranty	21

INTRODUCTION



INTENDED USE

Thank you for purchasing the TruAire-5 by Roscoe Medical 5-Liter Oxygen Concentrator. The intended function of the TruAire-5 Oxygen Concentrator is to provide supplemental oxygen to patients with respiratory disorders by separating nitrogen from room air, by way of a molecular sieve. It is not intended to sustain or support life.

CONTRAINDICATIONS

There are no known contraindications.



SAFETY SYMBOLS AND PRECAUTIONS

 DANGER	Indicates a potentially hazardous situation which, if not avoided, could result in death or serious injury.
 WARNING	Indicates a potentially hazardous situation which, if not avoided, could result in serious injury or equipment damage.
 CAUTION	Indicates a potentially hazardous situation which, if not avoided, may result in minor or moderate injury to the user or patient or damage to the device or other property.











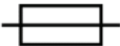





IMPORTANT SAFETY PRECAUTIONS AND WARNINGS



It is important that you read all warnings in user's manual before use. Use the product only for its intended use as described in the manual. Improper use can result in serious or fatal illness / injury, improper treatment or property damage. **DO NOT** attempt to operate this product without reading all instructions carefully. Save this manual for future reference.

 WARNING (USA only)	U.S. Federal Law restricts these devices to sale by, or on the order of, a physician or licensed practitioner. This device should only be used under the continued supervision of a physician or licensed practitioner.
 DANGER	THIS MEDICAL DEVICE IS NOT INTENDED TO BE USED AS A LIFE SUSTAINING OR LIFE SUPPORTING DEVICE.

LABELING SYMBOLS AND DESCRIPTIONS

Symbol	Description	Symbol	Description
	Alternating Current		Fuse
	Class II Equipment		Type BF applied part
	OFF (power)		ON (power)
	No Smoking		No Open Flame; Fire, Open Ignition Source and Smoking Prohibited
	Stacking Limitation		Consult Instructions for Use
	Serial Number		This Side Up
	Keep Dry		Fragile, handle with care
	Storage Temperature Range (32°F - 131°F)		Read the instruction manual/booklet prior to use.
Rx ONLY	U.S. Federal Law restricts this device to sale by, or on the order of, a physician or licensed practitioner.		
	Non-sterile		



WARNING

This product can expose you to chemicals including Lead and Diethylhexyl phthalate (DEHP) which are known to the State of California to cause cancer or birth defects or other reproductive harm. For more information visit: www.P65Warnings.ca.gov

SAFETY PRECAUTIONS AND WARNINGS



WARNING

- **BEFORE USE**, check the ratings label on the back of the device to ensure that the voltage and current indicated on the unit correspond with the voltage and current available. **DO NOT** overload wall outlets or use with power strips or extension cords.
- **DO NOT** use this product with a DC to AC converter, or with any AC voltage and/or frequency other than specified.
- **NEVER** operate this device if it has a damaged cord or plug, is not working properly or any abnormalities occur, or has been exposed to any liquids inside or outside of the housing. Contact your home care provider immediately.
- **NEVER** allow the power supply cord to be pulled, jerked, strained, twisted, or severely bent, especially at the plug connections. Damage will occur at the high flex point of entry into the appliance, causing it to rupture and short.
- **DO NOT** open or disassemble the compressor. Contact your home care provider for any service or repair requests.
- **DO NOT** use the device if it is damaged in any way. Continued use of a damaged device may cause injury to the patient or further damage to the device.
- Keep ALL electrical cords away from heated surfaces. **DO NOT** operate or store under direct sunlight, high temperature or humidity. See technical specifications for maximum storage and operating temperatures and relative humidity

DISCONTINUE OPERATION IMMEDIATELY IF ANY OF THE MOTOR HOUSING PARTS BECOME DETACHED OR BROKEN, EXPOSING THE MOTOR OR ANY OTHER INTERNAL ELECTRICAL COMPONENTS.

- There is a risk of fire associated with oxygen enrichment during oxygen therapy. **DO NOT** use the oxygen concentrator or accessories near sparks or open flames. **DO NOT** smoke while the oxygen concentrator is in use.
- Oxygen can make materials flammable. **DO NOT** leave the nasal cannula or mask on bed coverings, clothing or chair cushions. Turn the oxygen concentrator OFF when not in use.
- Keep the oxygen concentrator away from flammable and explosive areas.
- Patients who require continuous oxygen therapy should plan for alternate sources of power in the event of a power failure. This device is NOT intended to be used as a life sustaining or life supporting device.
- To avoid the risk of fire and burns, **NEVER** use petroleum or oil-based lotions or salves before or during oxygen therapy.
- **DO NOT** lubricate fittings, connections, tubing or other accessories of the device to avoid the risk of fire and burns.
- **NEVER** spray liquids onto the oxygen concentrator housing, especially near the display panel or air vents. Fluid could cause damage to the electrical components and lead to malfunction. If fluid enters the unit, discontinue use immediately and return the product to your home care provider.



WARNING (cont'd)

- **ALWAYS** unplug immediately after each use and keep unplugged when not in use. **DO NOT** run this product unattended.
- This device is to be used **ONLY** in accordance with the prescription of a physician and this user manual. If at any time the patient or attendant determines insufficient oxygen is being delivered, contact the provider and/or physician immediately. **DO NOT** make adjustments to the flow rate **UNLESS** prescribed by a physician.
- Close supervision is necessary when this device is used by or near children and physically or mentally impaired persons.
- If the electrical power source becomes unstable, discontinue use immediately and find an alternate power source.
- **ONLY** use stable and safe electrical power sources.
- **NEVER** block air openings of the oxygen concentrator or place it where the air openings may be obstructed. Keep the openings free from lint, hair, dust, etc.
- **ALWAYS** place the oxygen concentrator at least 4 inches away from walls, draperies, furniture, or similar surfaces. **ALWAYS** avoid deep pile carpets and heaters, radiators or hot air registers.
- **NEVER** drop or insert any object into any opening.
- **DO NOT** place the device in a confined area.
- The oxygen concentrator **MUST** be kept away from heat, fire, and excessive water sources and conditions at **ALL** times.
- **DO NOT** place items on top of the oxygen concentrator.
- **NEVER** use the oxygen concentrator in the presence of pollutants or fumes. The air intake and exhaust should be well-ventilated.
- **DO NOT** connect the oxygen concentrator in parallel or series with other oxygen concentrators or oxygen therapy devices.
- **ALWAYS** keep oxygen concentrator at least 10 feet away from wireless communication equipment such as wi-fi network devices, mobile phones, cordless phones and base stations, walkie-talkies, etc.
- **DO NOT** bring the oxygen concentrator or accessories into a Magnetic Resonance (MR) environment as it may cause unacceptable risk to the patient or damage to the oxygen concentrator or MR medical devices.
- **DO NOT** use this device or accessories in an environment with electromagnetic equipment such as CT scanners, Diathermy, RFID and electromagnetic security systems (metal detectors) as it may cause unacceptable stable risk to the patient or damage to the oxygen concentrator. Some electromagnetic sources may not be apparent; if you notice any unexplained changes in the performance of this device, or it is making unusual sounds, disconnect the power cord and discontinue use immediately. Contact your home care provider.
- This device is suitable for use in home and healthcare environments **EXCEPT** for near active HF surgical equipment and the RF shielded room of an ME system for magnetic resonance imaging, where the intensity of electromagnetic disturbances is high.
- Portable RF communications equipment (including peripherals such as antenna cables and external antennas) should be used no closer than 1 foot of the oxygen concentrator, otherwise degradation of the equipment could result.



DANGER

- Smoking during oxygen therapy is dangerous and is likely to result in facial burns or death. **DO NOT** allow smoking within the same room or vicinity of the oxygen concentrator, or any oxygen carrying accessories.
- Open flames during oxygen therapy are dangerous and likely to result in fire or death. **DO NOT** allow open flames within 10 feet of the oxygen concentrator or any oxygen carrying accessories.
- Users **MUST NOT** smoke while using this device. Keep ALL matches, lighted cigarettes or other sources of ignition out of the room or vicinity of the device. NO SMOKING signs should be prominently displayed. Textiles and other materials may easily ignite and burn with greater intensity in oxygen enriched air. Failure to observe this warning can result in severe fire, property damage and cause physical injury or death.
- A spontaneous and violent ignition may occur if oil, grease or greasy substances come in contact with oxygen under pressure. These substances **MUST** be kept away from the oxygen concentrator, tubing and connections, and all other oxygen equipment at ALL times.
- Avoid creation of any spark near the oxygen concentrator, including static electricity.
- Avoid use while bathing. If continuous usage is required under physician order, the concentrator **MUST** be in another room at least 10 feet from the bath or shower.
- **DO NOT** come into contact with the concentrator while wet.
- **DO NOT** place or store the concentrator where it can drop into water or any other liquid.
- **DO NOT** reach for product that has fallen into water. UNPLUG IMMEDIATELY and contact your home care provider for examination and repair.
- Seek immediate medical assistance in the event of discomfort or a medical emergency while undergoing oxygen therapy.



CAUTION

- Before use, check tubing and accessories for proper assembly. All parts should be firmly in place. Use of improperly assembled tubing and accessories could diminish or prevent adequate delivery of oxygen and the effectiveness of therapy.
- Tubing and accessories are for single patient use only. **DO NOT** share tubing and accessories with other patients.
- **DO NOT** modify this device without authorization of the manufacturer.
- The oxygen concentrator should **ALWAYS** be kept in the upright position to prevent damage.
- The oxygen concentrator cabinet should **ONLY** be opened by an authorized repair center.
- **DO NOT** service or maintain this device while in use.

ILLUSTRATION OF PARTS

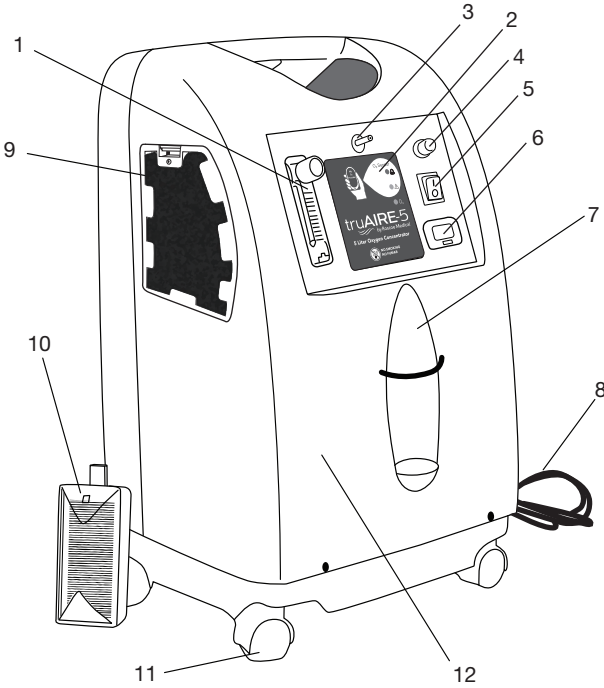

ITEM #O2C5L

Number	Description
1	Flowmeter
2	Status Indicator Light
3	Outlet Connector
4	Circuit Breaker
5	Power Switch
6	Hour Meter
7	Humidifier Bottle Holder
8	Power Cord
9	Cabinet Filter
10	Intake Filter
11	Caster Wheels
12	Cabinet Housing

TECHNICAL SPECIFICATIONS

Electrical Requirements	AC120V / 60 Hz; Power: 390VA
Rated Current Input	3.5A
Sound Level	≤50.5 dBA
Altitude	Up to 6000' without degradation of concentration levels Atmospheric Pressure Range: 12.47 psi-15.37 psi (86 kPa-106 kPa)
Oxygen Concentration	93% (±3%) at 0.5~5L/min after warmup period of 30 min.
Maximum Liter Flow	5L/min
Maximum Outlet Pressure	5.5 psi ±0.7 psi (35 kPa ± 5 kPa)
Low Flow Alarm	0.5-5 L/min
Filters	Cabinet, Compressor Inlet, Final Bacteria
Product Dimensions	13"L x 10.25"W x 21.25"H
Product Weight	35.5 lbs
Operating Ambient Temperature and Humidity	41°F-104°F (5°C-40°C), ≤80% RH
Storage and Transport Temperature and Humidity	32°F-131°F (0°C-55°C) 10%-90% RH
Electrical Classification	Class II equipment, Type BF applied part (nasal oxygen cannula), IP21
Mode of Operation	Continuous
Minimum Operation Time	30 minutes
Safety System	Low Pressure Alarm Low Oxygen Concentration Alarm High Pressure/High Temperature Shutdown Current Overload/Line Surge Shutdown
Maximum Cannula/Tubing Length	7' Cannula + 50' Oxygen Supply Tubing
Expected Life	6 Years
Warranty Period	5 Year Limited, 35,000 Hours on Parts
Software Version	A1.0
Flow Range at Outlet Pressure of 0 psi	0.5-5L/min
Flow Range at Outlet Pressure of 1 psi	0.5-5L/min
Change in maximum recommended flow when back pressure of 1 psi is applied	<0.5L/min CAUTION: Technical specifications for flowmeter calibration by manufacturer and tester. This device MUST be used according to manufacturer instructions and physician's order. DO NOT adjust the device flow.

GETTING STARTED

UNPACKING

- Check for any obvious damage to the carton or its contents. If damage is evident, please notify the delivery carrier or your home care provider.
- Remove all loose packing from the carton.
- Carefully remove the oxygen concentrator and all components from the carton.

NOTE: DO NOT dispose of the carton or packing materials. The oxygen concentrator will be required to ship in its original packaging for warranty repair or return.

NOTE: Store the oxygen concentrator in its original packaging until use is required.

PACKING LIST

- Oxygen Concentrator
- User Manual

INSPECTION

- Examine exterior of the oxygen concentrator for any visible damage, including nicks, dents, cracks, or scratches.
- Inspect all components, including accessories, display panel, power cord, caster wheels, etc.

STORAGE

- Whenever the oxygen concentrator is not in use, place back in the original packaging and store in a cool, dry area. **DO NOT** place anything on top of the repackaged concentrator.

OPERATING THE CONCENTRATOR

SELECT A LOCATION

Select a room in your home where placement of the oxygen concentrator is most convenient. Take into consideration the Safety Precautions & Warnings detailed on pages 4-7 of this manual. The oxygen concentrator can be rolled from room to room as needed.

SETTING UP THE CONCENTRATOR

Plug the oxygen concentrator power cord to an electrical outlet (see electrical requirements in Technical Specifications)

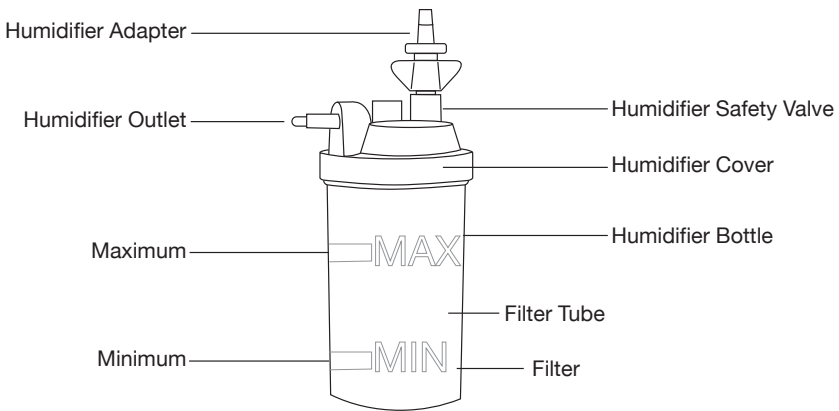

CONNECT HUMIDIFIER BOTTLE (IF PRESCRIBED, NOT INCLUDED)

- Remove cover from humidifier bottle
- Fill humidifier with purified or boiled (and cooled) tap water. **DO NOT** fill past the maximum water level line.

! WARNING: DO NOT fill humidifier with boiling water

- Tighten the humidifier bottle cover and secure in place by pulling the elastic band at the front of the device and sliding the humidifier bottle down toward the humidifier holder.
- Connect the humidifier to the air outlet using humidifier tubing.
- Connect the nasal cannula or oxygen mask tubing to the air outlet of the humidifier bottle.
- Press the power switch of the oxygen concentrator to the “on” position.
- After assembly, ensure oxygen flow through cannula or mask.

NOTE: Allow 30 minutes for the device to “warm up” to reach optimum oxygen concentration. Concentrator may be used during the initial warm up time.

FLOWRATE

- Turn the flowmeter knob to the setting prescribed by your physician.

NOTE: DO NOT set the flow above the red line on the flow-meter. An oxygen flow greater than 5 L/min will decrease the oxygen concentration.

NOTE: If the flow rate on the flowmeter falls below 0.5 L/min, check tubing or accessories for blocked or kinked tubing or a defective humidifier bottle.

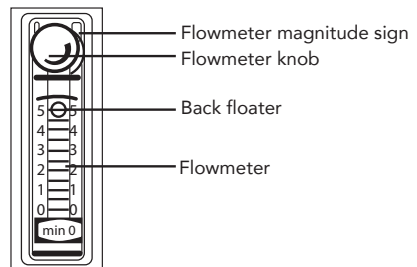

O₂ SENSOR AND ALARMS



Indicator	O ₂ Purity	Alarm	Details
Green	82% ±2%	No	Normal operation, no action needed.
Yellow	73%-82% ±2%	No	Continue use and call provider immediately. Ensure backup oxygen source is nearby
Yellow	N/A	Intermittent	Compressor failure, low/high pressure or low flow. Call provider immediately.
Red	<73% ±2%	Intermittent	Call provider and switch to backup oxygen source immediately.

TURNING OFF THE CONCENTRATOR

Press power switch to the “off” position and unplug the concentrator from the wall outlet.

MAINTENANCE

With proper care and maintenance, the TruAire-5 Oxygen Concentrator has an expected service life of six years of operation when used in accordance with the safety instructions, maintenance intervals and correct use stated in this manual. The effective service life can vary according to frequency and duration of use. Refer to the Preventive Maintenance Checklist in this manual for a schedule of recommended maintenance.

 **WARNING:** The oxygen concentrator regularly performs a self-check to verify pressure and oxygen concentration. There is no need for calibration of pressure or oxygen concentration. Annual maintenance is recommended for optimal performance and should **ONLY** be performed by an authorized repair center. **DO NOT** remove cabinet or attempt to make any repairs.

Compass Health Brands recommends use of original parts and filters for optimal performance of the device.

CLEANING THE CABINET

Check the exterior housing of the oxygen concentrator monthly for visible dirt or dust.

- Turn off the power switch and unplug the device.
- Using a damp cloth or sponge with a small amount of mild dish soap, gently clean the exterior case.
- Allow the surface to air dry or use a clean, dry towel to wipe up dampness before operating the concentrator.



WARNING

DO NOT use acetone, solvents or any other flammable products.

DO NOT spill liquid inside the cabinet

DO NOT use lubricants, oils or grease

DO NOT service or maintain while in use

DO NOT spray or apply any cleaning product directly to the cabinet

DO NOT hose down the product

CLEANING THE CABINET FILTER

- Turn off the power switch and unplug the device.

NOTE: Conditions in the home or facility may require more frequent inspection and cleaning of the filter, including high dust, air pollutants, pet fur and dander, etc.

- Carefully pull the cabinet filter from the side panel.
- Wash the filter in a solution of warm water and mild dish soap.
- Rinse thoroughly with warm tap water and gently squeeze excess water out. Allow to air dry or blow dry completely before reinstalling.

 **WARNING: DO NOT** operate the concentrator without the filters installed, or if filters are wet. Permanent damage to the concentrator could occur. The cabinet filter should be cleaned or switched to a clean filter weekly and replaced annually. Where the environmental conditions warrant, more frequent cleaning or filter changes may be required.

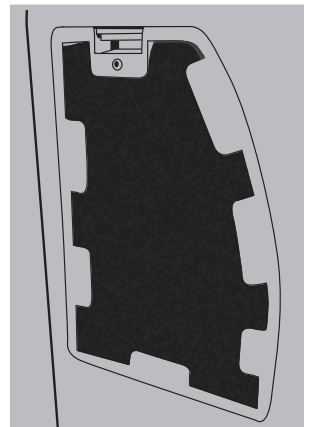

REPLACING THE INTAKE FILTER

 **WARNING:** The intake filter CANNOT be cleaned and should only be replaced.

NOTE: Intake filter replacement is recommended every 3 years. Filter cleaning/changes per the preventative maintenance schedule (see page 15) are minimum requirements. More frequent service, cleaning and filter changes may be required when the unit is used continuously and where environmental conditions warrant.

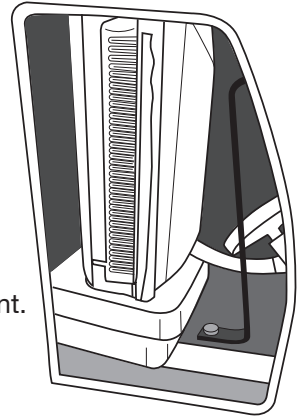

Intake and bacteria filter replacement should **ONLY** be completed by a qualified Dealer Technician. Failure to regularly inspect and change as detailed above may cause permanent damage to the device and may void the warranty.

CLEANING THE HUMIDIFIER BOTTLE (NOT INCLUDED)

NOTE: If using a humidifier, change the water daily. Clean the humidifier bottle and cover at least weekly.

- Wash the humidifier bottle and cover with warm water and mild dish soap, then rinse thoroughly with warm running water and dry.
- To disinfect the humidifier bottle and cover, soak in a solution of 1 part vinegar diluted with 10 parts water. Rinse thoroughly with warm running water and dry.

 **CAUTION:** To limit risk of bacterial growth, clean the humidifier and air dry thoroughly when concentrator is not in use.

CLEANING AND DISINFECTION BETWEEN PATIENTS

 **WARNING:** Cleaning and disinfection of the oxygen concentrator and accessories between patients should **ONLY** be performed by qualified personnel or an authorized repair center.

- Dispose of and replace all single patient accessories including:
 - o Nasal Cannula or Oxygen Mask and Supply Tubing
 - o Humidifier
 - o Filters
- Perform maintenance procedures described in this manual and the Preventive Maintenance Checklist.
- Check oxygen concentrator for any external damage that may require repair.
- Run checks to ensure the concentrator functions properly and all alarms are in working order.
- Ensure contents of package include concentrator and user manual.

PREVENTATIVE MAINTENANCE LOG

Model:

Serial Number:

EACH INSPECTION										
Date of Service										
Hour Meter Readout										
Clean Cabinet Filter (Weekly)										
Liter Flow Prescription										
PREVENTIVE MAINTENANCE SCHEDULE AND/OR BETWEEN PATIENTS*										
Oxygen Concentration (Every 36 months)										
Inspect/Replace Cabinet Filter*										
Inspect/Replace Bacteria Filter*										
Replace Compressor Intake Filter*										
Check Power Loss Alarm (Every 36 months)										

* Between patients or every 3 years. Filter cleaning/changes and maintenance checks are minimum requirements. More frequent service and cleaning may be required where environmental conditions warrant.

TROUBLESHOOTING GUIDE

SYMPTOM	PROBABLE CAUSE	SOLUTION	NOTES
<ul style="list-style-type: none"> * Green and Yellow lights on * Continuous Alarm * Concentrator stops running * Hour meter still elapsing time 	<ol style="list-style-type: none"> 1. The valve plug is loose 2. Exhaust sound buffer box jammed 3. Valve is blocked 4. Circuit board failure 	<ol style="list-style-type: none"> 1. Check and connect the valve plug to the circuit board. 2. Replace part. 3. Replace part. 4. Replace part. 	All repairs must be completed by an authorized repair center
<ul style="list-style-type: none"> * Nasal Cannula is fogging or has water droplets 	<ol style="list-style-type: none"> 1. Improper ventilation is causing elevated operating temperature 2. Compressor fan is not running or running slow 3. Water temperature in humidifier is too high 4. Water exceeds max level in humidifier 	<ol style="list-style-type: none"> 1. Ensure device is at least 4 inches from walls, heaters, or any other obstructions. 2. Remove any obstructions blocking the fan, or replace. 3. Add cold water to the humidifier bottle. 4. Remove excess water. 	All repairs must be completed by an authorized repair center
<ul style="list-style-type: none"> * Concentrator is running, but yellow light is on 	<ol style="list-style-type: none"> 1. Oxygen concentration is safe but decreasing 2. Unit is overheating due to blocked air intake 	<ol style="list-style-type: none"> 1. Clean or replace filters. 2. Ensure device is at least 4 inches from walls, heaters or any other obstructions. 	If issue persists, contact home care provider immediately.
<ul style="list-style-type: none"> * Concentrator is not running * Red light is on * Continuous audible alarm sounds 	<ol style="list-style-type: none"> 1. Low pressure 2. High pressure 	<ol style="list-style-type: none"> 1. Clean or replace filters. 2. Contact equipment provider immediately. 	If issue persists, contact home care provider immediately.
<ul style="list-style-type: none"> * Concentrator is not running * Continuous audible alarm sounds 	<ol style="list-style-type: none"> 1. Compressor open circuit alarm 2. Compressor short circuit alarm 	<ol style="list-style-type: none"> 1. Contact equipment provider immediately 2. Contact equipment provider immediately 	All repairs must be completed by an authorized repair center

EMC INFORMATION

Guidance and manufacturer declaration – electromagnetic emissions for all EQUIPMENT and SYSTEMS

Guidance and declaration of manufacturer -Electromagnetic emission		
The O2C5L Ni Oxygen Concentrator is intended for use in an environment specified below. The customer of the user of O2C5L Ni Oxygen Concentrator should assure that the unit is used in such an environment.		
Emission test	Compliance	Electromagnetic environment-regulations
RF emissions CIS-PR 11	Group 1	The O2C5L Ni Oxygen Concentrator uses RF energy solely for its internal function. Therefore, its RF emissions are very low and are not likely to cause any interference in nearby electronic equipment.
RF emissions CIS-PR 11	Class B	The O2C5L Ni Oxygen Concentrator is suitable for use in all establishments, including domestic and those directly connected to the public low- voltage power supply network that supplies building used for domestic purposes.
Emission of harmonics IEC 61000-3-2	Class A	
Voltage fluctuations / flicker emissions IEC 61000-3-3	Complies	

Guidance and manufacturer declaration – electromagnetic emissions for all EQUIPMENT and SYSTEMS

Guidance and manufacturer's declaration – electromagnetic immunity			
The O2C5L Ni OXYGEN CONCENTRATOR is intended for use in the electromagnetic environment specified below. The customer or the user of O2C5L Ni OXYGEN CONCENTRATOR should assure that it is used in such an environment.			
Immunity test	IEC 60601 test level	Compliance level	Electromagnetic environment - guidance
Electrostatic discharge (ESD) IEC 61000-4-2	±6 kV contact ±8 kV air	±6 kV contact ±8 kV air	Floors should be wood, concrete or ceramic tile. If floor are covered with synthetic material, the relative humidity should be at least 30%.
Electrical fast transient/burst IEC 61000-4-4	±2 kV for power supply lines	±2 kV for power supply lines	Mains power quality should be that of a typical commercial or hospital environment.
Surge IEC 61000-4-5	±1 kV differential mode ±2 kV common mode	±1 kV differential mode ±2 kV common mode	Mains power quality should be that of a typical commercial or hospital environment.
Voltage dips, short interruptions and voltage variations on power supply input lines IEC 61000-4-11	<5% UT (>95% dip in UT) for 0.5 cycle 40% UT (60% dip in UT) for 5 cycles 70% UT (30% dip in UT) for 25 cycles <5% UT (>95% dip in UT) for 5 sec	<5% UT (>95% dip in UT) for 0.5 cycle 40% UT (60% dip in UT) for 5 cycles 70% UT (30% dip in UT) for 25 cycles <5% UT (>95% dip in UT) for 5 sec	Mains power quality should be that of a typical commercial or hospital environment. If the user of the O2C5L Ni OXYGEN CONCENTRATOR requires continued operation during power mains interruptions, it is recommended that the O2C5L Ni OXYGEN CONCENTRATOR be powered from an uninterruptible power supply.
Power frequency (50/60Hz) magnetic field IEC 61000-4-8	3A/m	3A/m	Mains power quality should be that of a typical commercial or hospital environment.
NOTE UT is the AC mains voltage prior to application of the test level.			

Guidance and manufacturer declaration – electromagnetic immunity for EQUIPMENT and SYSTEMS that are not LIFE-SUPPORTING

Guidance and declaration of manufacturer - Electromagnetic Immunity For all Equipment and Systems that are not LIFE SUPPORTING			
The Oxygen Concentrator is intended for use in the electromagnetic environment specified below. The customer or the user of the Oxygen Concentrator should ensure that the unit is used in such an environment.			
Immunity test	IEC 60601 test level	Compliance level	Electromagnetic environment - guidance
<p>Conducted RF IEC 61000-4-6</p> <p>Radiated RF IEC 61000-4-3</p>	<p>3 Vrms 150 kHz to 80 MHz</p> <p>3 Vrms 80 MHz to 2.5 GHz</p>	<p>3 Vrms</p> <p>3 V/m</p>	<p>Portable and mobile RF communications equipment should be used no closer to any part of the OXYGEN CONCENTRATOR, including cables, than the recommended separation distance calculated from the equation applicable to the frequency of the transmitter.</p> <p>Recommended separation distance</p> $d = \left[\frac{3.5}{V_1} \right] \sqrt{P}$ $d = \left[\frac{3.5}{E_1} \right] \sqrt{P} \quad 80 \text{ MHz to } 800 \text{ MHz}$ $d = \left[\frac{7}{E_1} \right] \sqrt{P} \quad 800 \text{ MHz to } 2.5 \text{ GHz}$ <p>Where P the maximum output power rating of the transmitter in watts (W) according to the transmitter manufacturer and d is the recommended separation distance in metres (m).</p> <p>Field strengths from fixed RF transmitters, as determined by an electromagnetic site survey,^a should be less than the compliance level in each frequency range.^b</p> <p>Interference may occur in the vicinity of equipment marked with the following symbol: </p>
NOTE 1: At 80 MHz and 800 MHz, the higher frequency range applies.			
NOTE 2: These guidelines may not apply in all situations. Electromagnetic propagation is affected by absorption and reflection from structures, objects and people.			
<p>a. Field strengths from fixed transmitters, such as base stations for radio (cellular/cordless) telephones and land mobile radios, amateur radio, AM and FM radio broadcast and TV broadcast cannot be predicted theoretically with accuracy. To assess the electromagnetic environment due to fixed RF transmitters, an electromagnetic site survey should be considered. If the measured field strength in the location in which the OXYGEN CONCENTRATOR is used exceeds the applicable RF compliance level above, the OXYGEN CONCENTRATOR should be observed to verify normal operation. If abnormal performance is observed, additional measures may be necessary, such as reorienting or relocating the OXYGEN CONCENTRATOR.</p> <p>b. Over the frequency range 150 kHz to 80 MHz, field strengths should be less than 3 V/m.</p>			

Recommended separation distance between portable and mobile RF communications equipment and the EQUIPMENT or SYSTEM for EQUIPMENT or SYSTEM that are not LIFE-SUPPORTING

Recommended separation distances between portable and mobile RF communications equipment and the Equipment and Systems that are NOT LIFE SUPPORTING

The *OXYGEN CONCENTRATOR* is intended for use in an electromagnetic environment in which radiated RF disturbances are controlled. The customer or the user of the *OXYGEN CONCENTRATOR* can help prevent electromagnetic interference by maintaining a minimum distance between portable and mobile RF communications equipment (transmitters) and the *OXYGEN CONCENTRATOR* as recommended below, according to the maximum output power of

Rated maximum output power of transmitter (W)	Separation distance according to frequency of transmitter (m)		
	150 kHz to 80 MHz $d = \left[\frac{3.5}{V_1} \right] \sqrt{P}$	80 MHz to 800 MHz $d = \left[\frac{3.5}{E_1} \right] \sqrt{P}$	800 MHz to 2.5 GHz $d = \left[\frac{7}{E_1} \right] \sqrt{P}$
0.01	0.12	0.12	0.23
0.1	0.37	0.37	0.74
1	1.17	1.17	2.33
10	3.69	3.69	7.38
100	11.67	11.67	23.33

For transmitters rated at a maximum output power not listed above, the recommended separation distance d in meters (m) can be estimated using the equation applicable to the frequency of the transmitter, where P is the maximum output power rating of the transmitter in watts (W) according to the transmitter manufacturer.

NOTE 1 At 80 MHz and 800 MHz, the separation distance for the higher frequency range applies.

NOTE 2 These guidelines may not apply in all situations. Electromagnetic propagation is affected by absorption and reflection from structures, objects, and people.

LIMITED WARRANTY

Compass Health Brands Corp. warrants the TruAIRE-5 5 Liter Stationary Oxygen Concentrator by Roscoe Medical to be free from defects in workmanship and materials and will perform in accordance with the product specifications for a period of five (5) years or 35,000 hours from date of shipment to the original dealer who purchased the unit unless contractually specified otherwise. Coverage does not extend beyond 36 months on basic wear components including cup seals and sieve beds. This warranty is limited to exclusions set forth within this warranty and is also limited to product repair (parts and labor) by a Compass Health Trained and Certified Repair Technician or Compass Authorized Service Center. Routine maintenance items such as filters are not covered under this warranty, nor does it cover normal wear and tear. It is at Compass Health's sole discretion to request a copy of the maintenance record for the unit to qualify the claim and also to make the decision on whether to repair or replace a defective unit and Compass Health reserves the right to provide adjustment instructions and/or replacement parts to the dealer or user to perform a repair or adjustment or to replace a defective part. Replacement parts/components are warranted for the unexpired portion of the original Limited Warranty of the unit. This warranty only applies to the labor for repairs performed by a Compass Health Trained and Certified Repair Technician or Compass Health Authorized Service Centers. It does not apply to the labor performed by the purchaser or user. The need for a repair under this warranty does not obligate Compass Health to provide a loaner unit during the time that a unit is being shipped to and from an Authorized Service Center and for the time it is being repaired. This Warranty does not cover odors, stains, or fading of colors of the exterior of the unit from exposure to chemicals, heat or light nor does it cover damage associated with spills. This warranty shall be void and Compass Health shall be relieved of any obligation or liability associated if:

- Unqualified service personnel attempt to repair the device while under warranty or there has been an attempt to open or service the 4-Way Valve by anyone other than a Compass Health Trained and Certified Repair Technician or Compass Authorized Service Center.
- The device has been misused, altered, used improperly, or used for any purpose other than what the product was originally designed.
- Malfunction results from inadequate cleaning or failure to follow the use and maintenance schedule including, but not limited to, proper cleaning and frequency of filter replacement necessary based upon environmental conditions.
- Unauthorized parts, components, filters, or regenerated sieve material is utilized in the unauthorized repair of a device.

THIS WARRANTY HAS BEEN DRAFTED TO COMPLY WITH FEDERAL LAW. THERE IS NO OTHER EXPRESS WARRANTY, IMPLIED WARRANTIES, INCLUDING THOSE OF MERCHANTABILITY AND FITNESS FOR A PARTICULAR PURPOSE, ARE LIMITED TO THE DURATION OF THE EXPRESS LIMITED WARRANTY AND TO THE EXTENT PERMITTED BY LAW ANY AND ALL IMPLIED WARRANTIES ARE EXCLUDED. THIS IS THE EXCLUSIVE REMEDY AND LIABILITY FOR CONSEQUENTIAL AND INCIDENTAL DAMAGES UNDER ANY AND ALL WARRANTIES ARE EXCLUDED TO THE

EXTENT EXCLUSION IS PERMITTED BY LAW. COMPASS HEALTH BRANDS CORP DISCLAIMS ALL LIABILITY FOR ECONOMIC LOSS, LOSS OF PROFITS, OVERHEAD, CONSEQUENTIAL OR PUNITIVE DAMAGES WHICH MAY BE CLAIMED TO ARISE FROM ANY SALE OR USE OF THIS PRODUCT OR TO PRODUCTS DAMAGED BY CIRCUMSTANCES BEYOND COMPASS HEALTH BRAND CORP'S CONTROL. COMPASS HEALTH BRAND CORP'S SOLE REMEDY TO THE ORIGINAL PURCHASER, IF ANY, IS LIMITED TO THE PRICE PAID FOR THE DEVICE OR PARTS & REPAIRS OF THE DEVICE ISSUE GIVING RISE TO THE CLAIM. SOME STATES **DO NOT** ALLOW THE EXCLUSION OR LIMITATION OF INCIDENTAL OR CONSEQUENTIAL DAMAGES, LIMITATIONS ON HOW LONG AN IMPLIED WARRANTY LASTS OR THE LIMITATION OR EXCLUSION OF CONSEQUENTIAL OR INCIDENTAL DAMAGES, SO THE ABOVE LIMITATION OR EXCLUSION MAY NOT APPLY TO YOU. THIS WARRANTY GIVES YOU SPECIFIC LEGAL RIGHTS, AND YOU MAY ALSO HAVE OTHER RIGHTS THAT VARY FROM STATE TO STATE.

WARRANTY CLAIM SUBMISSION

The original purchaser must submit any warranty claim to include the serial number of the affected unit and a copy of their original invoice from Compass Health Brands or an Authorized Compass Health Brands dealer directly to Compass Health Brands Corp.. Upon verification of the purchaser and warranty status, Compass Health will assign an RMA (Return Merchandise Authorization) for the Dealer along with instructions for the shipping of the affected unit to a Compass Health Authorized Service Center. Where feasible, and at the discretion of Compass Health Brands, the product owner may choose to arrange for a Compass Health Trained and Certified Repair Technician to conduct an onsite repair. For all returns to be sent by mail/courier, the original purchaser must:

1. Properly package the unit in an original, TruAIRE-5 approved shipping carton with both top and bottom protective inserts
2. Properly display the Return Authorization Number on the shipping carton
3. Send the shipment to the designated Authorized Repair Center freight prepaid

When the device is repaired and tested it will be returned to the original purchaser to an address within the 48 continental United States via the most economical means and at the expense of Compass Health Brands Corp. If expedited repair and/or alternate or expedited return shipping is desired by the original purchaser, the coordination of and incremental expense for the expedited repair and shipping will be the complete responsibility of the original purchaser. Compass Health Brands recommends that the shipping party fully insure the concentrator, at their expense, in the event of damage or loss when in transit to Compass Health Brands or its authorized repair facility.

NOTES

COMPASSHEALTH

Manufactured for
Compass Health Brands Corp.
6753 Engle Rd.
Middleburg Heights, OH 44130
www.compasshealthbrands.com
Phone: 800.376.7263
Made in China
O2C5L_Manual_04_240205 ©2024